

**ELLIET**<sup>®</sup>

MANUAL

**CAMELEON  
M360-M450**



This booklet provides information about the actual use and maintenance of the machine. **Read it carefully and keep it in a safe place for future reference.**



Please also keep your **purchasing invoice** or receipt together with this booklet.



**Register** your purchase online on **[www.elieta.eu](http://www.elieta.eu)**.

© ELIET

Copyright 2015 ELIET. All rights reserved. All textual material, drawings, illustrations, diagrams, graphs, etc., included in this ELIET booklet are protected by copyright and also by other intellectual property rights. None of this information may be copied for commercial purposes or distribution and/or changed or reposted for other purposes. The copyright on the content included in this ELIET manual remains the exclusive property of its respective owners.

# 1. Introduction

---



## 1.1 Read this operation manual carefully

---

ELIET machines are designed for safe and reliable use if they are operated in accordance with the instructions provided. Carefully read these operating instructions before using the machine. Failure to do so may result in personal injury or damage to the equipment.

## 1.2 Identification data- ELIET Cameleon M360-M450

---

Copy the identification data of your machine into the text boxes:

Item number:	<input type="text" value="MA 029"/>
Serial number:	<input type="text"/>
Year of manufacture:	<input type="text"/>
Purchase date :	<input type="text"/>

# 2. Warranty

---



## 2.1 Registratration of the machine

---

In order to be able to make a warranty claim, you will need to register your machine online within one month after purchase: **[www.elietau](http://www.elietau) / [www.elietau](http://www.elietau)**

European customers : ELIET EUROPE NV  
Diesveldstraat 2  
8553 Otegem - Belgium  
**T** (+32)(0)56 77 70 88 - **F** (+32)(0)56 77 52 13  
**[www.elietau](http://www.elietau)**

US customers : ELIET USA Inc.  
3361 Stafford street - USA  
Pittsburgh, PA 15204 - USA  
**T** 412 367 5185 - **F** 412 774 1970  
**[www.elietau](http://www.elietau)**

Read the warranty conditions "15. Warranty Conditions" on page 34

## 3. Welcome

---



### **Welcome to the family of ELIET users.**

We thank you for the trust that you have placed in ELIET and we are convinced that you have purchased the very best machine. The operating life of your ELIET machine depends on how you care for your machine. Strict adherence to the instructions and suggestions in these manuals will guarantee optimum performance of your ELIET machine for a very long time.

Read this manual carefully before operating the machine. This will prevent you from operating the device incorrectly. For your own safety, please observe the safety instructions specified in the relevant chapter. Even if you are thoroughly familiar with operating such equipment, it is still advisable to read these pages carefully.

All ELIET equipment and machines are continually being updated and improved and therefore the specification of your machine may differ slightly in terms of shape, technology and accessories. The descriptions and technical data in this manual are accurate at the time of printing. Certain illustrations and descriptions may not be applicable to your specific machine, but instead relate to a different version of the machine. We trust therefore that you will understand that the texts and illustrations in this manual cannot give rise to any claims. If you still have questions after reading this manual, please contact your ELIET dealer. Find an official ELIET dealer near you on [www.eliyet.eu](http://www.eliyet.eu).

## **ELIET AT YOUR SERVICE**

During office hours ELIET's help desk will make every effort to answer all of your questions:

European customers GMT +1: from 08:00 a.m. to 18:00 p.m.

Tel: +32 56 77 70 88

Fax: +32 56 77 52 13

[Service@eliyet.be](mailto:Service@eliyet.be)

# 4. Table of Contents

<b>1. Introduction</b>	<b>3</b>
<b>2. Warranty</b>	<b>3</b>
2.1 Registratration of the machine	3
<b>3. Welcome</b>	<b>4</b>
<b>4. Table of Contents</b>	<b>5</b>
<b>5. Operator safety symbols</b>	<b>7</b>
5.1 For your information	7
5.2 Caution	7
5.3 Warning	7
<b>6. Main machine parts</b>	<b>8</b>
6.1. General overview	8
6.2 Engine	9
<b>7. Safety instructions</b>	<b>10</b>
7.1 Safety messages	10
7.2 Safety features	11
7.3 Safety instructions	12
7.3.1 General safety instructions	12
7.3.2 Careful and cautious use	13
7.3.3 Operator's responsibilities	13
7.3.4 Personal Protective Equipment (PPE)	14
7.3.5 Danger zone	14
7.3.6 Periodic maintenance	14
7.3.7 In harmony with nature	15
<b>8. Dealer's duties</b>	<b>16</b>
8.1 Other duties	16
<b>9. Operating instructions</b>	<b>17</b>
9.1 Preliminary checks	17
9.2 Adding fuel	17
9.3 Preparing the work site	18
9.4 Starting the petrol engine	18
9.5 Operating the machine	19
9.5.1 Prior to starting the work	19
9.5.2 During work	20
9.6 Cleaning the machine	21
9.6.1 Het belang van het reinigen	21
9.6.2 What does cleaning involve?	22
<b>10. Transporting the machine</b>	<b>24</b>
<b>11. Maintenance</b>	<b>25</b>
11.1 General	25
11.2 Routine checks to be carried out before each operation	25
11.2.1 Visual check of the state of the machine	26

11.2.2 Checking the engine's oil level .....	26
11.2.3 Cleaning the air filter .....	26
11.2.4 Checking the propeller .....	26
11.3 Maintenance after 20 hours of operation .....	28
11.3.1 General lubrication treatment .....	28
11.3.2 Changing the oil .....	29
11.3.3 Checking the spark plug .....	29
11.3.4 Changing the air filter .....	30
<b>12. Storing the machine .....</b>	<b>31</b>
<b>13. Equipment specifications .....</b>	<b>32</b>
<b>14. EC Declaration of Conformity .....</b>	<b>33</b>
<b>15. Warranty Conditions .....</b>	<b>34</b>

## 5. Operator safety symbols

ELIET cannot anticipate every situation in which a risk or danger can occur. The warning symbols in this operating manual and the labels on the machine are therefore not comprehensive. Although minimal, a residual risk will always be present. If while operating the machine you apply a working method, operation or technique that is not explicitly recommended by ELIET, make sure that it does not represent a danger for bystanders.



A number of symbols ("For your information", "Caution", "Warning") are used in this operating manual to provide additional information and to highlight dangers.

### 5.1 For your information



#### **For your information:**

This symbol is used to draw your attention to specific information and/or actions, or to indicate where you can find additional information on the subject.

### 5.2 Caution



#### **Caution:**

This symbol suggests safe practices. The purpose is to prevent incorrect operation that could result in personal injury or damage to the machine.

### 5.3 Warning



#### **Warning:**

This symbol warns you about extreme danger that you must take notice of in those specific circumstances. So for the sake of your own safety, remain alert at all times.

These safety messages can only warn of, but not remove the danger. Both the use of common sense and proper observation of the guidelines in this manual are essential to prevent accidents.

## 6. Main machine parts

To fully understand the content of this operating manual you need to be fully conversant with the terminology used for the descriptions. This chapter refers to a broad range of machine parts and identifies their names. We recommend that you take the time to study the machine prior to its use for a better understanding of the descriptions provided in this operating manual.

### 6.1. General overview

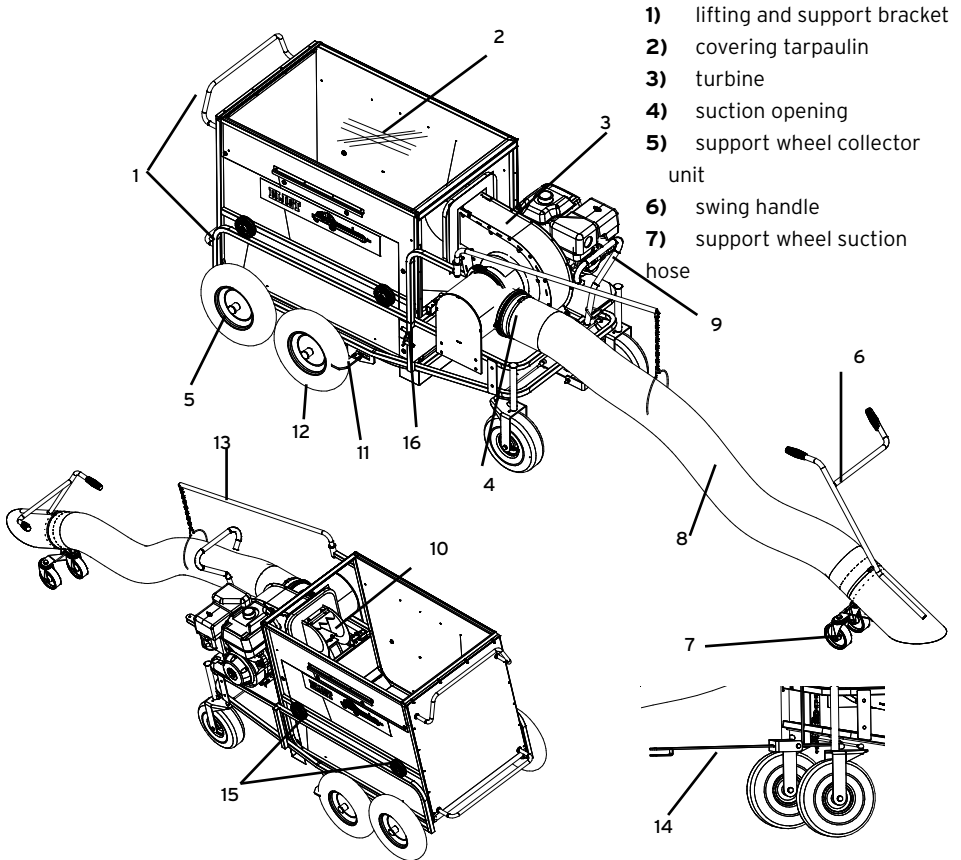

- 1) lifting and support bracket
- 2) covering tarpaulin
- 3) turbine
- 4) suction opening
- 5) support wheel collector unit
- 6) swing handle
- 7) support wheel suction hose

- 8) suction hose
- 9) steer
- 10) discharge opening
- 11) brake
- 12) machine supporting wheel

- 13) support suction hose
- 14) trailer hitch
- 15) guiding wheels collector unit
- 16) latch for the collector unit



## 6.2 Engine

B&S Vanguard 5,5pk series 800



9pk Subaru EX27

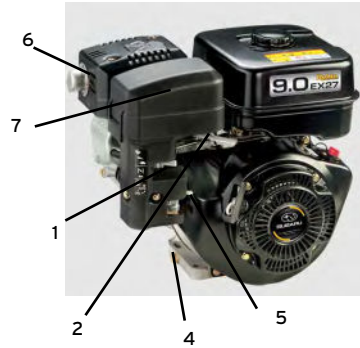

1. Choke
2. Speed control
3. Oil filler cap/dip stick
4. Oil drain plug
5. Fuel tap
6. Exhaust
7. Air filter



### For your information:

Your ELIET dealer remains at your service for any maintenance or advice, ensuring your ELIET machine is always in perfect condition. You can contact him for original ELIET parts and lubricants at any time. These service parts are manufactured according to the same strict rules and craftsmanship as the original equipment. (Find a dealer near you on [www.elieta.eu](http://www.elieta.eu))



### Caution:

For your own safety, only genuine parts should be mounted on ELIET machines. For a list of original spare parts and their ordering codes please visit [www.elieta.eu](http://www.elieta.eu).

## 7. Safety instructions



### 7.1 Safety messages

The safety messages are clearly indicated on the machine with stickers or relief pictograms. Take good notice of the symbols and warning messages displayed.



This sticker is affixed near the exhaust and warns the operator of hot surfaces with a high risk of burns.

Item no.: BQ 505 010 060



This sticker groups a number of key safety messages and information about the machine and the manufacturer:

Some safety instructions are symbolised by icons:

- 1.** Before operating the machine the manual should be read and understood.
- 2.** Suitable safety clothing (gloves, safety goggles, ear protection) must be worn when operating the machine.
- 3.** There is a real risk of severe injuries including permanent damage to the hands. Never place your hands near the blade while it is still operating.
- 5.** There is a real risk of severe injuries with permanent damage to the eyes or face as a result of flying debris.

Item no.: BQ 505 010 050



This sticker notifies the operator that the engine must be turned off and the spark plug cap removed before starting maintenance on the machine.

Item no.: BQ 505 010 040

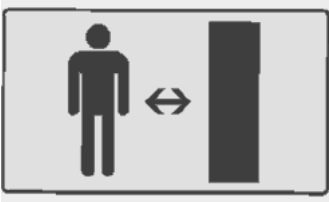

This sticker reminds the user that bystanders should observe a minimum distance from the machine.

Item no.: BQ 505 010 150



This unique sticker contains all machine identification data.

- Year of manufacture
- Model
- Type number
- Serial number
- Capacity
- Weight
- Guaranteed A-weighted noise level

In addition, the sticker bears the manufacturer's company information. The sticker bears the seal of conformity with European standards in the form of a CE label.



#### Caution:

Safety stickers or parts that include safety information that are damaged due to use or cleaning, have become illegible or have been removed must be replaced immediately. Stickers and parts can be obtained from any authorised ELIET dealer.

## 7.2 Safety features



#### Warning:

Never attempt to circumvent or disengage safety devices. Safety measures were designed for your safety. Before using the machine, the operator should check that the safety device works properly. Any defects must be repaired prior to using the machine.

**Turbine housing:** All outward-rotating parts that could potentially cause accidents are adequately shielded by a protective cover.

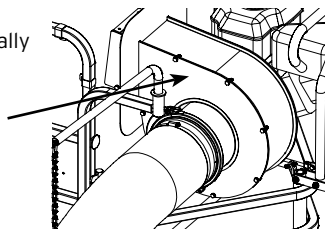

**Safety contact suction arm:** As soon as the suction is removed from the turbine, the engine will disengage. This safety precaution prevents the operator from reaching into the turbine while the propeller is running.

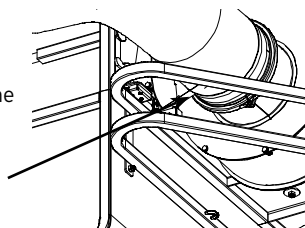

**Ergonomic handle:** An ergonomic handle with supporting wheel provides for easy handling of the suction hose.

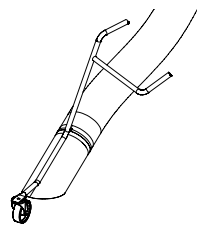

**Brake:** Releasing the handle will induce the brakes to block automatically.

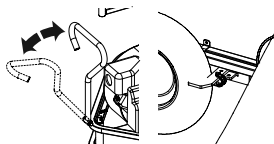

**Safety contact collector unit:** As soon as the collector unit is removed, both the engine and the turbine will disengage.

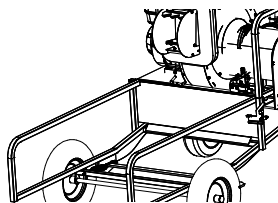

## 7.3 Safety instructions

### 7.3.1 General safety instructions

- The owner of the machine will keep this manual during its complete service life. A reference guide for the user, it also ensures that the machine is used and maintained correctly at all times. Always refer to this instruction manual if you have any doubts about an operation that you are about to perform.
- If the instructions stated in this manual are not clear to you, do not hesitate to contact your Eliet dealer for further explanation. In addition, the ELIET help desk is at your service during

office hours to answer any questions you may have (EU +32 56 77 70 88).

- Be sure to read the chapter which is intended for the dealer ("8. Dealer's duties" on page 16) and verify whether the machine was delivered in accordance with the instructions.
- After you purchase the machine, allow the dealer or a professional to give you some instructions regarding correct use.
- Carefully observe all safety instructions when using this ELIET machine ! Carefully read all the instructions relating to the operation of the machine. All these instructions are important for your own personal safety.
- Always observe the applicable regulations of the Labour Inspectorate to avoid accidents.
- Read and observe all safety messages indicated on the machine in the form of stickers or icons.
- Under no conditions whatsoever may the original design of the machine be modified without written consent of ELIET EUROPE NV (Belgium).

### **7.3.2 Careful and cautious use**

- The purpose of this machine is to suction organic materials and debris from the garden and must be used for this purpose only.
- Think about what you are doing at every manoeuvre. Do not be tempted to let routine dull your attention. Never act impulsively or on reflex.
- People with heart problems and/or balance disturbances are advised against operating this machine.
- Although the machine is equipped with extensive safety features, please avoid dangerous situations.
- Never work with a machine that has not been fully assembled. Check the finish of the machine to ensure compliance with the instructions provided in this manual.
- Make a thorough inspection of the area where the machine is to be used. Remove sticks, stones, wires and debris, but also take account of electric cables, water pipes, sprinkler heads, etc.
- The only safe position for the operator while operating the machine is at the handlebar.
- Never work when light intensity is below 500 Lux.
- Never attempt to change a machine setting and never perform maintenance when the motor is running.
- The machine may cause an explosion when you work near flammable products, fumes, etc.

### **7.3.3 Operator's responsibilities**

- All persons using the machine are assumed to be fully conversant with the safety instructions. **The operator is fully liable for the use of the machine in regard to himself and to third parties.**
- The operator of this machine is assumed mature enough and with enough common sense to make decisions by himself.
- The machine may not be operated by minors. However, this does not apply to youths over the age of 16 who are learning to operate the machine under the supervision of an experienced operator. This manual must be read before use.

- Children (under 16 years of age) and animals should be kept at a safe distance (10 m) from the machine.
- ELIET advises against lending the machine to others, but if this should occur, it should only be lent to persons who are familiar it. **Always make sure that the user is aware of the potential hazards and ensure that he/she reads the manual before using the machine.**
- This machine must only be operated by persons who have a good physical condition. Take a rest if you become tired while operating the machine. Do not operate the machine after alcohol or hallucinogenic drug use.

### **7.3.4 Personal Protective Equipment (PPE)**

- The person operating this machine must wear suitable clothing, i.e. clothing covering the entire body, protective gloves and closed footwear.
- For protection of the most sensitive senses, ELIET recommends hearing protection and safety goggles.

### **7.3.5 Danger zone**

The safe position for the operator is at the handlebar of the suction hose.

- Never allow bystanders within the danger zone - a circle of 10 m around the machine - during work.
- Do not take any risks! Disengage the machine as soon as someone enters into the danger zone.
- Shut off the engine when leaving the machine unattended.
- Once the motor is running, focus all your attention on operating the machine.

### **7.3.6 Periodic maintenance**



#### **For your information:**

For your own safety and in the interest of extending the life of the machine, this machine should undergo regular maintenance.

- Periodic maintenance is essential. You must therefore strictly follow the maintenance schedule in this operating manual.
- Draw up a maintenance register in which you keep the performed maintenance updated in detail.
- Regular cleaning of the machine is essential. In particular, keep the air supply for ventilation of the motor free from obstructions. This will prevent overheating and consequential damage to the machine.
- Always request genuine ELIET replacement parts from your ELIET dealer if parts require replacement due to wear or failure. This is important for guaranteeing your own safety (find an official ELIET dealer near you on [www.elieta.eu](http://www.elieta.eu))

- For a list of original replacement parts and their ordering codes please visit **[www.eliect.eu](http://www.eliect.eu)**.
- Always make sure the engine is switched off and the spark plug removed before performing repairs or maintenance.
- Always wear suitable clothing for performing maintenance.

### **7.3.7 In harmony with nature**

Use the machine in a manner that respects environmental regulations:

Avoid running the machine when you're not using it.

Avoid spillage of fuel while refuelling.

Service the engine regularly to ensure optimum combustion.

## 8. Dealer's duties

---

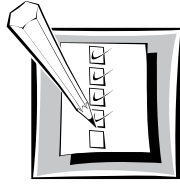

### Warning:

As an ELIET dealer you **must** familiarize your customers with the **operation of the machine** and also **point out the possible dangers** while using it. You are expected to carefully go over the maintenance points of the machine together with the new owner. Repeat these instructions until the new owner has fully understood everything.

- ELIET machines are packaged in accordance with common rules for proper transportation. Deliveries are always ex factory. Consequently, ELIET cannot be held liable for any damage occurred during transport.
- If the packaging is damaged upon receipt of the goods, check the state of the machine to ensure it is not damaged. Report any irregularities on the delivery order before signing for receipt.
- In case of damage to the machine a complaint to the shipping company must be submitted immediately after delivery.

### 8.1 Other duties

---

Machines do not contain any oil or fuel when they are packed for transport. The dealer must check the oil level and refill if necessary according to the instructions in this manual (or those pertaining to the engine manual).

Every ELIET dealer warrants a long life span of ELIET machines. He will lubricate the hinges before delivering the machine to the client.

The rpm will be set at 3,200 rpm.

Finally, the dealer will ensure that the warranty card is completed and signed. The purpose is to avoid warranty disputes. **Please read the warranty conditions for more details.**

Please register your product online immediately after purchase to ensure that your warranty entitlement is activated. ([www.eliyet.eu](http://www.eliyet.eu)).



# 9. Operating instructions

---

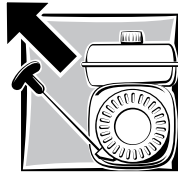

## 9.1 Preliminary checks

---



**Caution:**

Try making a habit of checking the following points before getting to work with the machine:

**Checklist**

1. Check the oil level. (read "11.2.2 Checking the engine's oil level" on page 26).
2. Check that the fuel tank is full. If it is not, add fuel (read "9.2 Adding fuel" on page 17).
3. Check that the air filter is not heavily soiled (if necessary, read "11.2.3 Cleaning the air filter" on page 26)
4. Check that the propeller is in a good condition. If the propeller shows ruptures or fractures, it must be repaired prior to use.
5. Check that the tensioning bolts of the propeller are sufficiently tight.
6. Prior to starting any work, the operator must check that all protective covers are in place and correctly fixed.

## 9.2 Adding fuel

---

When the machine is running low on fuel it must be refuelled. The use of fresh petrol is recommended at all times.

Use unleaded petrol with an octane index of at least 85, but preferably 98 or 99. Use of any other fuel is prohibited (please check the engine manual).



**Warning:**

Under certain conditions, petrol is extremely flammable and highly explosive. Fire breakouts and petrol explosions can inflict severe burns and cause damage to personal property.

- Never refuel while the engine is running. Always allow the engine to cool down for several minutes before refuelling.
- Use fresh fuel only.
- Given the limited shelf life of petrol, ELIET recommends purchasing small amounts.
- Store the fuel in an approved tank. Keep it out of reach of children.
- Store the petrol in a well-ventilated area, away from fire, sparks or heat sources.
- Never refuel at the location where the machine will be operated. Keep a distance of at least 10 m from the selected work area in view of fire hazard.
- Clean the area around the fuel cap (1) and remove it. Never fill the tank completely. Always fill it up to approximately 20 millimetres from the brim. So never fill it up to the brim.
- Always use a funnel or a spout for refuelling. Special funnels are available from your ELIET dealer.
- Put the cap back on the fuel tank as quickly as possible.
- Also ensure that clothing does not come in contact with the petrol. If this happens, it must be changed immediately.
- It is strictly prohibited to refill the tank around people who are smoking or near open fire.
- If fuel is swallowed or comes in contact with the eyes, consult a doctor immediately.

### 9.3 Preparing the work site

---

- Clean up the area where the machine will be operated prior to starting the work.
- Foreign objects are to be removed from the work area.
- Foreign objects include anything non-organic (e.g. metal, stone, synthetic materials, ropes, textiles, etc.). Some of these items can cause severe damage to your machine.

### 9.4 Starting the petrol engine

---



**Caution:**

Please read the safety instructions under "7.3 Safety instructions" on page 12



**Caution:**

Never start the engine if the cooling fins are dirty. The engine would heat up too quickly, which would pose a fire risk.



**For your information:**

For more information, please check the engine manual.



**Warning:**

Never start the engine in a closed environment. The exhaust fumes contain toxins that may cause poisoning or suffocation.

Always check the engine for adequate oil and fuel levels before starting it. If necessary read the following paragraphs:

"11.2.2 Checking the engine's oil level" on page 26

"9.2 Adding fuel" on page 17



**For your information:**

For placement of the parts, please check the engine manual.

- a. Open the throttle.
- b. Close the choke.
- c. Open the fuel tap.
- d. Pull the starter cord to start the engine.
- e. Quickly open the choke when the engine has engaged (to avoid the engine from receiving excess fuel).
- f. Leave the engine to warm up for a few seconds.

Failure to open the choke will cause the engine to slow down and to produce smoke. It will eventually come to a stop. The solution is to simply restart the engine without opening the choke.

The engine's failure to restart could indicate a soaked spark plug which then needs to be replaced.

## 9.5 Operating the machine

---

### 9.5.1 Prior to starting the work

- The operator must wear clothing, protective gloves and other protective attributes as prescribed in this manual (see "7.3 Safety instructions" on page 12).
- A good gardener works efficiently and according to a well defined plan. It allows him to keep an overview of his work and prevents accidents or wrong manoeuvres with the machine.

- A standard suction hose measures 3.5 metres in length and thus provides suction over a width of 7 metres. This must be taken into consideration before defining the work route.
- In view of the risk of carbon monoxide poisoning from the exhaust, the machine must never be run in a closed environment.

### **9.5.2 During work**

- The operator must be alert while he's working. As long as he is operating the machine, his full attention must be on the job.
- Start the engine as described in the preparations section above.
- The engine will run only with the suction arm attached to the suction opening of the turbine and if the collector unit is mounted correctly. Disengaging the functionality of the safety switches in any way is strictly prohibited.
- The engine must be disengaged immediately if the machine produces unfamiliar sounds. Examine the defect and perform any necessary repairs before continuing.



#### **Warning:**

Any suboptimal performance of the machine can compromise the operator's safety.

- While performing suction, the suction mouth must never be fully pressed to the ground. Always allow for suction of sufficient air.
- Clotted leaves and humid materials may block the suction hose. Their suctioning must be therefore be done with caution and step-by-step, not all at once.
- Should the hose get blocked nonetheless, one may attempt to loosen the lump by tapping on the hose or moving it back and fro at the location of the blockage.

#### **Emptying the collector unit.**

- To empty the collector unit, release the latch at the front of the collector unit.

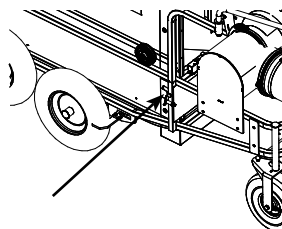

- Using the supports, the unit can now be slid from the chassis. Place one foot on the lower support to balance the unit.
- The collector unit has been equipped with guiding wheels, that ensure an easy gliding of the collector unit out of the chassis.

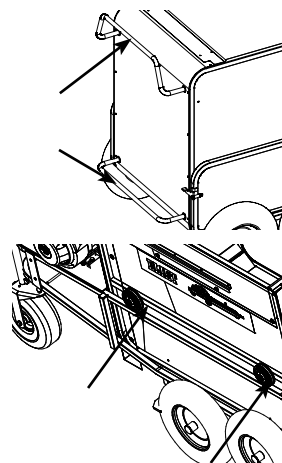

### Attaching the Cameleon M to a tractor.

The trailer hitch on the Cameleon M allows for attachment to a tractor.

The machine can thus be pulled towards the dumping site where you want to empty the collector unit.

It also allows for transport by tractor across larger distances.

Prior to attaching the Cameleon M to a trailer hitch, the brake must be engaged

Dit doet men door de ketting die van de trekbeugel naar de remgeleider loopt, vast te haken aan het voorziene haakje. Hierdoor zet men de rem vast in de vrije positie.

This is done by hooking the chain that goes from the guidance to the brake on the hook. This converts the brake stuck in the free position.

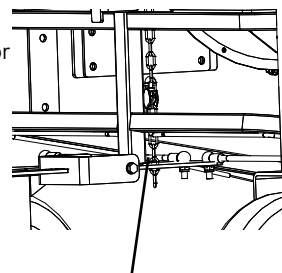

## 9.6 Cleaning the machine

### 9.6.1 The importance of cleaning

ELIET recommends cleaning the machine after each use. We recommend performing an inspection each time you clean the machine to check component and machine integrity. It allows timely intervention and prevention of any defects, ensuring a longer service life of your machine.

Failure to clean the machine will lead to:

- Accelerated wear
- Increased risk of fire
- Reduced engine cooling
- Increased risk of short circuits
- Reduced performance
- Illegibility of safety stickers
- Failure to notice defects or wear at an early stage



**Caution:**

Wear suitable clothing for cleaning activities. Utility gloves are essential.



**Caution:**

Failure to perform the daily clean-up will result in loss of warranty.



**Caution:**

Cleaning activities to the machine must always be carried out with the engine turned off. Wear suitable clothing for cleaning activities. Utility gloves are essential.

## 9.6.2 What does cleaning involve?

Cleaning the machine implies a thorough check-up and inspection of the machine. Check that no parts have been deformed, that welded seams are not cracked and that parts do not exhibit excess play.

Any necessary replacement and/or repair works must be undertaken immediately. Ask your authorised ELIET dealer to carry out repairs (find an authorised ELIET dealer near you [www.elieta.eu](http://www.elieta.eu)).

Cleaning the machine involves more than just cleaning the outside. Open all protective covers so that you can also clean the inside of your machine.

- Use penetrating oil with MoS2 to remove grease and lubricants. The latter is a lubricant and rust solvent at the same time.
  - Using a dry cloth, remove any dirt from the frame. Pay special attention to places where stickers with safety messages are displayed (do not use any cleaning products that affect paint or stickers).
  - Any stickers that are no longer legible must be replaced. Original stickers can be purchased from your ELIET dealer.
  - Compressed air can be used to easily blow out and clean some parts.
- 
- Pay particular attention to cleaning the engine. Cooling fins and air inlets are of key importance to guarantee adequate cooling of the engine.
  - Use of a steamer to clean the machine is allowed. Do not spray excessive amounts of water on the bearings, electric contacts and filler caps. Water is the number one cause of rust and this must be avoided at all times. Allow the engine to cool down properly before treating it with water.

## 10. Transporting the machine

---

- Only adults are permitted to move or transport the machine.
- During transport, children, unauthorised people or animals must not be allowed within a 2 m radius of the machine.
- For safe transport it is essential that the Cameleon be attached firmly to the trailer or the van. Make sure the machine is firmly lashed up.
- Always transport your machine with its engine turned off.
- Avoid very rough terrain; the transport route is preferably flat, with an even surface.
- The danger zone remains in effect while the machine is being transported.



# 11. Maintenance

---



## 11.1 General

---

ELIET recommends that the machine be brought to an official ELIET dealer for a major overhaul each year (find an authorised ELIET dealer near you on [www.elieta.eu](http://www.elieta.eu)). Your ELIET dealer is at your service for maintenance and advice at all times. He stocks genuine ELIET replacement parts and lubricants. His staff can always obtain advice and service from ELIET's help desk in order to provide you with an impeccable after-sales service.

Maintenance must always be carried out in an area intended for that purpose. The area must meet the following criteria:

- Spacious
- Dust-free
- Easily accessible
- Clean and tidy
- Well lit
- Quiet

These characteristics are important for proper performance of the maintenance works.



### Warning:

Maintenance performed in an incorrect manner may compromise the operator's safety. Damage or consequential damage that arises from insufficient or faulty maintenance will void the warranty. Maintenance must therefore be performed by expert and experienced engineers at all times.

## 11.2 Routine checks to be carried out before each operation

---



### Caution:

Maintenance must always be carried out with the engine turned off.

## 11.2.1 Visual check of the state of the machine

Check whether any parts have been deformed and check for torn welds and any excess play on parts. If problems are found, repairs must be carried out first.

## 11.2.2 Checking the engine's oil level

- Take a clean cloth.
- Pull the dipstick from the filler opening.
- The oil level will usually be hard to read immediately. Wipe the dipstick with your clean towel and re-insert it without fastening it.
- Pull the dipstick out again; you will now get an accurate reading of the oil level.
- The oil sticking to the dipstick should be between the minimum and maximum mark.

## 11.2.3 Cleaning the air filter

The type of air filter may differ slightly depending on the engine brand and type.

- The air filter is located under the black protection cover, next to the fuel reservoir on the machine.
- Loosen the black protection cover.
- There are two types of filters: the common sponge filter and a paper filter, similar to the air filter of a car.
- Sponge filters can be cleaned by rinsing them with some petrol and blowing them with compressed air.
- Paper filters are cleaned by dusting them down or cleaning with compressed air.
- After cleaning, replace all parts into their original positions.



### **Caution:**

Should the machine have toppled over for some reason, you must set it upright again as soon as possible. The unusual position of the engine may have caused oil to seep from the crankcase via the carburettor onto the air filter. Oil on the filter paper obstructs the air passage and the filter must therefore be replaced.

## 11.2.4 Checking the propeller

For your and other people's safety it is of key importance to regularly check the propeller for ruptures. The easy procedure starts by sliding the suction arm from the inlet opening.

This is done by loosening the tensioning ring around the suction hose.

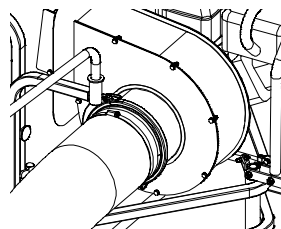

A torch will be required to now inspect the dark turbine area.

- In order to demount the propeller, the full front plate of the suction unit must be detached.
- To do this, loosen the 9 M6 bolts on the front plate.

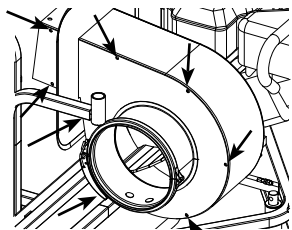

- Now slide the front plate to the right for easy removal.

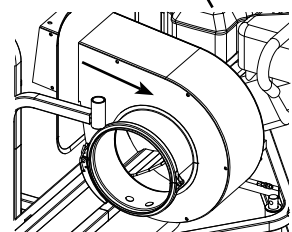

- The front plate removed, we now have easy access to the propeller. It is mounted directly onto the crankshaft. The propeller attachment is hidden behind a propeller hood.

**How to detach the propeller hood?**

- At the heart of the propeller is a conic drill socket. There are three holes, two of which carry a socket-head screw.
- One of the screws should be loosened completely, the other only half.
- The fully loosened screw is then screwed into the hole that was initially empty. After screwing it in, secure it tightly. While securing it, the two parts of the socket head will come apart.
- The entire propeller can now be slid from the crankshaft.
- Make sure not to lose the wedge that is in the crankshaft while demounting the socket head.

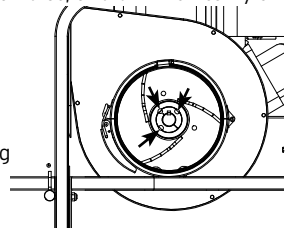

## 11.3 Maintenance after 20 hours of operation

### 11.3.1 General lubrication treatment

For proper operation of the machine it is recommended to lubricate it at regular intervals.

Lubricate hinges and friction points.

Lubricating nipples



#### Caution:

As for other maintenance, the engine must be switched off and the spark plug removed before performing any lubricating activities. Protective gloves must be worn.

#### Lubricate via available nipples.

The swivel caster at the front of the Cameleon M 360-M 450 contains a lubricant nipple.

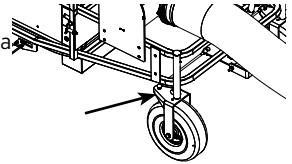

How to proceed:

- Clean the nipple.
- Push new lubricant through the nipple with a special lubricant pump.
- ELIET recommends Sunoco Multi Purpose Grease.
- One or two pump-fulls will suffice to redistribute the new grease.
- Remove the grease that protrudes via the seams.

#### Lubricating hinges

Hinges can be found in these locations:

The pivot point of the skip.

The pivot point of the latch on the collector unit.

The pivot point of the supporting arm.

- Start by spraying some penetrating oil into the hinges. Allow it to sit for a while.
- Then wipe away old lubricant with a cloth or paper tissue.
- Once the hinges have been cleaned, spray them with Novatio White Supreme Grease.
- All lubricants indicated are available from your ELIET dealer.

## Lubricants

Engine	1.1 L	SUNOCO SUPER DENALUBE SAE 20 W 50 API SF / CC
Hinges		NOVATIO WHITE SUPREME GREASE
Wheel axles		SUNOCO GREASE MULTI-PURPOSE LR - EP2

### 11.3.2 Changing the oil

- Ensure that the engine is on an even surface and turned off.
- At the rear of the engine, below the engine foot, a bolt is affixed to the crankcase.
- Have a one litre collection reservoir ready before loosening the bolt.
- Empty the full contents (0.6 l) from the engine.
- Replace the bolt on the drain. Wipe away any spilled oil with a clean cloth.
- Refill the engine with fresh 4 stroke oil. ELIET recommends a top quality high-detergent oil: SUNOCO DENALUBE SAE 20W50 API SF / CC.
- Pour 0.6 l of oil into the filler opening.
- Remove any spilled oil after filling. Before checking the oil level with the dipstick, leave the engine untouched until all the oil has found its way into the crankcase.
- Place the dipstick in the filler opening without fastening it. After pulling it out again, the oil attached to the dipstick should reach the maximum mark. If it doesn't, more oil must be added.



#### **Warning:**

Oil shortage inevitably causes severe engine damage.

### 11.3.3 Checking the spark plug

ELIET suggests the following spark plugs:

NGK	BPM 7 A
CHAMPION	BS 19 LM

- Turn off the engine and pull the cable from the spark plug.
- Clean the area around the spark plug and remove the spark plug from the cylinder head.
- The distance between the electrodes is 0.8 mm.
- If the spark plug is heavily contaminated or dirty, it must be replaced.
- Complete the following steps to verify ignition quality:



1. Replace the spark plug cap on the plug.
  2. Grab the rubber of the spark plug cap and press the outermost electrodes against the mass of the engine.
  3. Pull the starter cord.
  4. Check for sparks between the electrodes.
  5. The spark plug is in good condition if the sparks are clear and neatly centred between the electrodes.
  6. Weak, irregular and off-centre sparks indicate that the spark plug must be changed.
- Replace the new or old spark plug with care so as not to damage the screw thread. Secure the spark plug with a torque of 20 Nm.

### **11.3.4 Changing the air filter**

- This procedure is identical to cleaning the air filter (“11.2.3 Cleaning the air filter” on page 26)
- Contact your ELIET dealer or authorised engine service centre to purchase the proper air filter.

## 12. Storing the machine

---

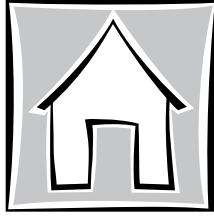

### Storage preparations

- Clean the machine (read "9.6 Cleaning the machine" on page 21).

### Properties of a storage area

- The machine must be stored in a dry area away from precipitation.
- The temperature in the storage area must be between 5 °C and 40 °C.
- Store the machine out of the reach of children.
- Never store the machine near heat sources or open flames (observe at least 2 m distance).
- If the machine is stored outdoors, it must be properly covered with canvas. Avoid direct precipitation on the machine. ELIET highly recommends a sheltered storage place.

### Storing

- Always allow the engine to cool down before storage.
- When storing the machine for an extended period, we recommend that you follow the steps below:
- Check all nuts and bolts and fasten them where necessary.
- To avoid rust on the machine, touch up all chipped areas or treat them with anti-rust grease. Original paints/enamels in the appropriate colours are available from your ELIET dealer.

# 13. Equipment specifications



Engine	9 pk Subaru EX27
RPM	3200 t/min
Propeller	Steel
Suction mouth	Ø 193,5 mm
Suction hose	3,5 m
Noise reduction	rubber
Chassis	galvanised 0,8 mm
Dimensions (LxWxH in mm)	180x800x1040 mm
Weight (empty)	117 kg
Transmission	Direct
Volume collector unit	700L
Options	Shredder unit



# 14. EC Declaration of Conformity

---

Machine : **VACUUM**  
Type : **ELIET Cameleon M360-M450**  
Model number: **MA 019 450 438**  
**MA 016 360 438**

The previously mentioned machine has been designed and manufactured to comply with the following European CE regulations :

**EN 15503: "Garden equipment - Garden blowers, vacuums and blower/vacuums - Safety"**

ELIET mfg. cy. hereby declares that after performing a hazard analysis, it is fully aware of the potential hazards and risks associated with the machine. In this knowledge, the necessary steps have been taken in line with Machine Directive 2006/42/EC in order to ensure absolute operator safety for the operator, when the machine is used correctly.

The value of the measured sound power level and the guaranteed sound power level were obtained according to the procedures set forward in the directive 2000/14/EG annex III/B clause 35 and directive EN 13503.

Measured sound power level LwA : 100 dB(A)  
Guaranteed A-weighted sound power level : 101 dB(A)

Date: 01/01/14

signature:



Frederic LIETAER  
Managing Director ELIET EUROPE NV

ELIET EUROPE NV  
Diesveldstraat 2  
BE - 8553 Otegem Belgium  
Ph. +32 56 77 70 88 - Fax +32 56 77 52 13  
info@eliet.eu - www.eliet.eu

# 15. Warranty Conditions

---

Dear Customer,

Thank you for placing your confidence in ELIET. We are convinced that the appliance you have chosen will fulfill your needs and expectations over the coming years. ELIET is committed to guaranteeing the good performance of its products.

## What is warranty ?

ELIET's product design and manufacture procedures are subject to strict quality guidelines, aimed at **guaranteeing** a long product life and permanent safety. To ensure this, ELIET will repair any **hidden defects or abnormalities** throughout the warranty period, provided you **use your machine as instructed**.

## Warranty conditions

ELIET's warranty obligations for new machines is governed by the following conditions.

### **I. Warranty period**

The warranty period starts the day the dealer delivers the machine to the customer (date of invoice) and expires

- after two years of private use.
  - after twelve months or 100 running hours\* of rental use.
  - after twelve months or 100 running hours\* in semi-professional or in professional use.
- To be eligible to obtain warranty the customer is invited to register the newly purchased machine with ELIET. You should complete the registration online on Eliet's webiste :

**[www.elieta.eu](http://www.elieta.eu)**

\* what is reached first

### **II. Non-applicability of the warranty**

- Wearing parts like knives, bearings, belts, chains, cogwheels, tires, lamps, fuses, etc. are not covered by the warranty.
- When the defect is shown to be caused by improper handling, improper use, negligence or consequential damage that occurs as a result of external influences (fall, broken stones, foreign object, accident).
- When the defect is shown to be caused by a lack of periodic maintenance or cleaning of reinigen van de machine in accordance with the prescribed periodic maintenance.
- If it turns out that the defect was caused by acting against the instructions or advice of the user manual in.
- When the defect occurs after a repair by an unofficial ELIET dealer or a repair using parts that are not original ELIET parts.
- When the defect is shown to be due to the unauthorized modification of the machine's original construction.
- When the defect occurs after use of the machine contravening the instructions for use

in the manual.

- When the warranty procedure is not followed or after the end of the warranty term.
- For all problems relating to the motor, please contact an authorized service centre of the engine manufacturer.

### III.Procedure

- **Step 1:** On the date of purchase, the customer should register his/her purchase online by completing the registration card at **www.elieta.eu**.
- **Step 2:** In the event of a defect becoming apparent, the customer shall have this verified by the authorized ELIET dealer. If the dealer feels that there is a factory defect, the dealer may invoke the warranty, under the terms specified.
- **Step 3:** Every warranty application must be accompanied by a fully completed official application form. Copies of this warranty application are available to dealers at ELIET or even at an importer/agent.
- **Step 4:** The dealer then orders the parts needed to perform the repairs. Next, the dealer faxes the order form together with the completed warranty form.
- **Step 5:** The warranty form should be stapled to the purchase invoice and mailed to ELIET or an importer/agent of ELIET.
- **Step 6:** ELIET will send the parts ordered to the dealer under the regular delivery and payment conditions.
- **Step 7:** The defective part will be examined by the technical department first prior to approving or rejecting the warranty. ELIET reserve the right to solely decide whether or not the customer has complied with the conditions for the validity of this warranty, i.e. 1 year or 2 years. Faulty components shall become the property of ELIET.
- **Step 8:** When a warranty claim is found to be valid, ELIET will credit the warranty parts. Customers shall never be entitled to apply for a refund of labour costs.

### IV.In case of damage caused by transport

- All goods are supplied ex factory. Transport risks are borne by the customer. It follows, that ELIET highly recommend to check the goods for damage on arrival.
- Any damage found should be stated on the delivery form before signing. Make sure the driver of the haulage company puts his signature next to the damage on your copy.
- In the absence of a written and signed declaration on the delivery form, the insurance of the haulage company will not accept any liability.
- Damages can be claimed from the hauler using a copy of the delivery form and a covering letter stating your complaint.
- The damaged machine should be kept in its original condition until the hauler's insurer has performed any examination.

EIJET®

| [NL](#) [FR](#) [EN](#) [DE](#)

PRODUCTS ▾
SERVICE ▾
DEALERS ▾
SECOND HAND
ABOUT EIJET ▾
PRODUCT REGISTRATION
LOGIN

### product registration

**Contact**

Company	<input type="text"/>
Firstname	<input type="text"/>
Name	<input type="text"/>
Address	<input type="text"/>
Postal code	<input type="text"/>
City	<input type="text"/>
Country	Belgium ▾
Phone (insert country code)	<input type="text"/>
Fax	<input type="text"/>
E-mail address	<input type="text"/>
VAT number	<input type="text"/>

**Machine**

Machine	<input type="text" value="-- choose here --"/> ▾	<i>Is your machine not mentioned in this list ? Then contact Eljet at +32 56 77 70 88 or <a href="mailto:info@eljet.eu">info@eljet.eu</a></i>
Serial number:	<input type="text"/>	
Date of purchase	<input type="text" value="30/09/2015"/>	

**General information**

This machine will mainly be used for:

private use  
 professional use  
 rental

I have a garden measuring:

< 50 m²  
 50 - 200 m²  
 200 - 1000 m²  
 1000 - 5000 m²  
 > 5000m²

Name dealer:

Did the dealer give you sufficient information on the operation of the machine?  
 Yes  No

Did the dealer go through the maintenance schedule with you?  
 Yes  No

Did you receive the manual that is delivered with the machine?  
 Yes  No

I give my consent to use my personal data for administrative reasons

